

CAT:	FEET:
------	-------

TYPE:	PROJECT:
-------	----------

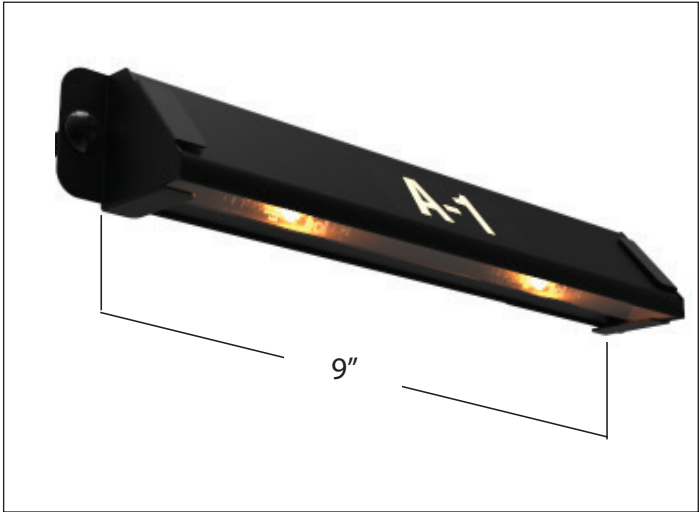

Discreet, seat-mounted, hidden source LED lighting system featuring an optically clear directional lens.

Features

- Compact (9" x 1 1/4" x 1 1/4") tamper-resistant fixture offers hidden linear light source.
- Optically clear polycarbonate co-extruded directional lens features 90° lighting cut-off for hidden, discreet illumination. An optional row indicator window is available.
- Efficient, modular design incorporates replaceable PCB that easily snaps into Titanium series modules for easy and economical maintenance. Includes 48" Super-flex conduit for wireway connection.
- Use with Two-Tone Bullnose stair nosing with wireway reflective edge.

Mounting

Fantasma™ Seat Light is adaptable for stationary no pivot arms, hard or fabric surface mount. Suggested mounting height above floor is 12"-16".

Applications

Ideal for seat mounted aisle lighting applications.

Warranty

5 years



Technical Information

LEDs Brightness	Low	Standard
*Lumens/ft	28	42
*Watts/unit	1.1	1.62
Lumen/watt	26	
CRI	>80/TYP83	
Kelvin Temp	1900K, 2700K, 3000K, 3500K, 4000K (+/- 80K) 3SDCM, Red, Blue, Amber	
Rated Life	75,000 hrs.	
Operating Voltage	12V DC	
Power Supply	Class 2	
Dimmable	Yes	

* 3000K Sample

Profile Dimensions

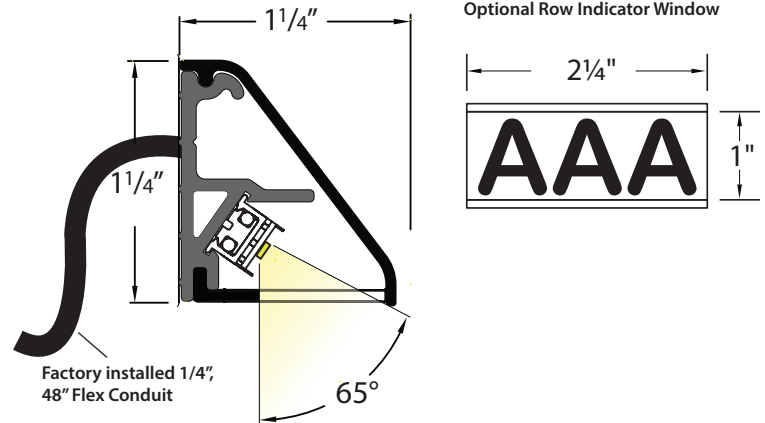



Recommended Power Supplies

ADUL - NON DIMMING

DESCRIPTION	CAT NO	APPLICATION	PRIMARY VOLTAGE	SECONDARY VOLTAGE	CIRCUIT BREAKERS	MAX LOAD	CIRCUIT CAPACITY
ADUL Series Class 2 Transformer	ADUL-80-1-5-12-D	Indoor / Damp	100-277V AC 50/60 HZ	12V DC	1	60W	5A
	ADUL-150-2-5-12-D				2	2x60W	2x5A
	ADUL-240-3-5-12-D				3	3x60W	3x5A
	ADUL-320-4-5-12-D				4	4x60W	4x5A

ADUL - 0-10V DIMMING

DESCRIPTION	CAT NO	APPLICATION	PRIMARY VOLTAGE	SECONDARY VOLTAGE	CIRCUIT BREAKERS	MAX LOAD	CIRCUIT CAPACITY
ADUL Series Class 2 Transformer	ADUL-80-1-5-12-DOT	Indoor / Damp	100-277V AC 50/60 HZ	12V DC	1	60W	5A
	ADUL-150-2-5-12-DOT				2	2x60W	2x5A
	ADUL-240-3-5-12-DOT				3	3x60W	3x5A
	ADUL-320-4-5-12-DOT				4	4x60W	4x5A

ADUL - DMX SINGLE ADDRESS

DESCRIPTION	CAT NO	APPLICATION	PRIMARY VOLTAGE	SECONDARY VOLTAGE	CIRCUIT BREAKERS	MAX LOAD	CIRCUIT CAPACITY
ADUL Series Class 2 Transformer	ADUL-80-1-5-12-DIN	Indoor / Damp	100-277V AC 50/60 Hz	12V DC	1	60W	5A
	ADUL-150-2-5-12-DIN				2	2x60W	2x5A
	ADUL-240-3-5-12-DIN				3	3x60W	3x5A

ADUL - DMX MULTI ADDRESS

DESCRIPTION	CAT NO	APPLICATION	PRIMARY VOLTAGE	SECONDARY VOLTAGE	CIRCUIT BREAKERS	MAX LOAD	CIRCUIT CAPACITY
ADUL Series Class 2 Transformer	ADUL-150-2-5-12-DIN-2	Indoor / Damp	100-277V AC 50/60 Hz	12V DC	2	2x60W	2x5A
	ADUL-240-3-5-12-DIN-3				3	3x60W	3x5A
	ADUL-320-4-5-12-DIN-4				4	4x60W	4x5A

INFINITY - MLV / ELV / 0-10V / PWM / TRIAC

DESCRIPTION	CAT NO	APPLICATION	PRIMARY VOLTAGE	SECONDARY VOLTAGE	CIRCUIT BREAKERS	MAX LOAD	MIN LOAD	CIRCUIT CAPACITY
Infinity Series Class 2 Transformer	INF-J-30-1-2.5-12	Indoor / Outdoor	100 - 277V AC	12VDC	1	30W	3W	2.5A
	INF-J-60-1-5-12				1	60W	6W	5A
	INF-J-180-3-5-12				3	3x60W	3x6W	3x5A
	INF-J-300-5-5-12				5	5x60W	5x6W	5x5A

Recommended Dimmers

DIMMING - 0-10V

DESCRIPTION	CAT NO	APPLICATION	INPUT VOLTAGE	OUTPUT VOLTAGE	MAX LOAD
0-10V Dimmer	DIM-LD-010	Indoor	24V DC	24V DC	30 mA max. output (sink only)

DIMMING - MLV

DESCRIPTION	CAT NO	APPLICATION	INPUT VOLTAGE	OUTPUT VOLTAGE	MAX LOAD
MLV Dimmer	N-600	Indoor	120V AC	120V AC	450W
	N-1000				800W
	N-1500				1200W
	D-600				450W
	M-600				450W
	M-1000				800W

DIMMING - ELV

DESCRIPTION	CAT NO	APPLICATION	INPUT VOLTAGE	OUTPUT VOLTAGE	MAX LOAD
ELV Dimmer	ME-600	Indoor	120V AC	120V AC	450W
	DE-300				300W

DIMMING - DMX

DESCRIPTION	CAT NO	APPLICATION	INPUT VOLTAGE	OUTPUT PROTOCOL	MAX UNIVERSE
DMX Controller	TVOQ-1-WH	Indoor	5V DC	DMX 512	1
	TVOQ-2-BK		6V DC		
	TVOQ-2-WH				
	TVOQ-10-BK-7		6-7V DC		2
	TVOQ-10-WH-7				



TVOQ-1-WH
WH (White only)

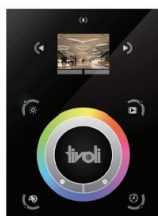

TVOQ-10-XX-7
XX = BK (Black), WH (White)

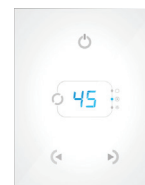

TVOQ-2-XX
XX = BK (Black), WH (White)

Ordering Information

PRODUCT CODE	FEEDPOINT	LED BOTTOM	NUMBER OF LED PCB	FINISH	OPTIONAL ROW INDICATION	INDICATOR COLOR	REQUIRED POWER SUPPLY
FST	-	-	-	M	-	-	PSU
FST = Fantasma Seat Titanium	C = Center R = Right L = Left	19 = 1900K 27 = 2700K 30 = 3000K 35 = 3500K 40 = 4000K AM = Amber RD = Red BL = Blue	02 = Low Brightness 03 = Standard Brightness	M = Matte	RI = Row Indication* <i>Row indicator option requires written details with order</i>	19 = 1900K 27 = 2700K 30 = 3000K 35 = 3500K 40 = 4000K AM = Amber RD = Red BL = Blue	See above
					*Leave blank if not required.		

Mounting Accessories

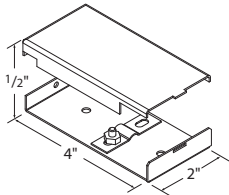

JBOX-LP
Junction box, low profile

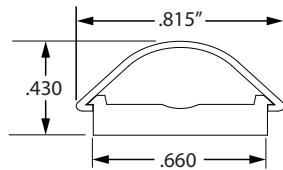

BS-CC-8
Wall wireway, 8' Black Base & Conduit Cover



BSL-PC-1/4
¼" Flex Conduit, Black

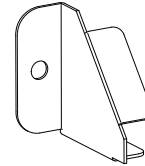

FANTASMA END CAP
FWTT-EC-L
Left End Cap (shown)
FWTT-EC-R
Right End Cap

Replacement Parts

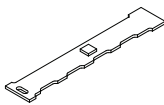

REPLACEMENT PCB
FTT-LED-19
1900K
FTT-LED-27
2700K
FTT-LED-30
3000K
FTT-LED-35
3500K
FTT-LED-40
4000K
FTT-LED-AM
Amber
FTT-LED-BL
Blue
FTT-LED-RD
Red

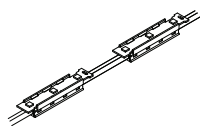

LOW BRIGHTNESS REPLACEMENT STRAND WITH 2 LED PCB
FTT-02-STRAND-19
Replacement Strand With 1900K LED
FTT-02-STRAND-27
Replacement Strand With 2700K LED
FTT-02-STRAND-30
Replacement Strand With 3000K LED
FTT-02-STRAND-35
Replacement Strand With 3500K LED
FTT-02-STRAND-40
Replacement Strand With 4000K LED
FTT-02-STRAND-AM
Replacement Strand With Amber LED
FTT-02-STRAND-BL
Replacement Strand With Blue LED
FTT-02-STRAND-RD
Replacement Strand With Red LED

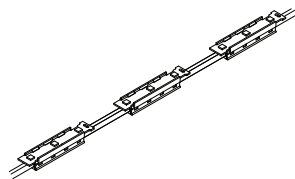

STANDARD BRIGHTNESS REPLACEMENT STRAND WITH 3 LED PCB
FTT-03-STRAND-19
Replacement Strand With 1900K LED
FTT-03-STRAND-27
Replacement Strand With 2700K LED
FTT-03-STRAND-30
Replacement Strand With 3000K LED
FTT-03-STRAND-35
Replacement Strand With 3500K LED
FTT-03-STRAND-40
Replacement Strand With 4000K LED
FTT-03-STRAND-AM
Replacement Strand With Amber LED
FTT-03-STRAND-BL
Replacement Strand With Blue LED
FTT-03-STRAND-RD
Replacement Strand With Red LED

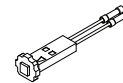

ROW INDICATOR LED
FTT-RI-19
1900K
FTT-RI-27
2700K
FTT-RI-30
3000K
FTT-RI-35
3500K
FTT-RI-40
4000K
FTT-RI-AM
Amber
FTT-RI-RD
Red
FTT-RI-BL
Blue

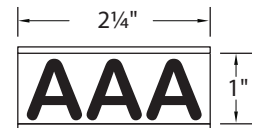

REPLACEMENT WINDOW ONLY
Snaps easily into position along installed base and interconnects with outer lens cover for seamless profile.
FTT-WINDOW

TwoTone Bullnose & Accessories

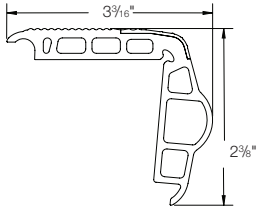

Bullnose Extrusion
BNS-TT-GY-12

TwoTone Bullnose, 12' length, Black/Gray Strip
BNS-TT2-GY-12
TwoTone Bullnose, 12' length, Black/2" Gray Strip
BNS-SC-GY-12
Bullnose, Solid Gray, 12' Length

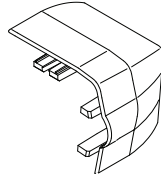

Bullnose End Caps
BNS-TT-EC-L

End Cap, Left Side Overlap Design, Black
BNS-TT-EC-R
End Cap, Right Side Overlap Design, Black

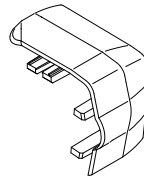

CC Bullnose End Caps (Carpet-To-Carpet)

BNS-CC-TT-EC-L
End Cap, Carpet-To-Carpet, Left Side, Black
BNS-CC-TT-EC-R
End Cap, Carpet-To-Carpet, Right, Black

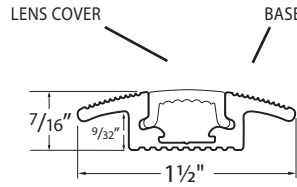

CC & CW Wire Way Combo - Base & Lens
WW-CC-BK-8

Carpet to Carpet Base and Cover 8' - Black
WW-CC-GY-8
Carpet to Carpet Base and Cover 8' - Gray
WW-CW-BK-8
Carpet to Wall Base and Cover 8' - Black
WW-CW-GY-8
Carpet to Wall Base and Cover 8' - Gray

CC & CW Wire Way Base ONLY
WW-CW-BS-8

Base Only, Carpet to Wall, Black, 8'
WW-CC-BS-8
Base Only, Carpet to Carpet, Black, 8'

CC & CW Wire Way Lens ONLY

WW-TC-CL-8
Lens Cover Only, Clear, 8'
WW-TC-BK-8
Lens Cover Only, Black, 8'
WW-TC-BZ-8
Lens Cover Only, Bronze, 8'
WW-TC-GY-8
Lens Cover Only, Gray, 8'

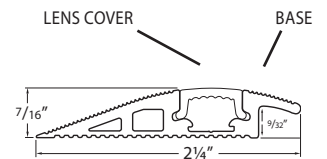

CE Wire Way Combo - Base & Lens
WW-CE-BK-8

Carpet to Edge Base and Cover 8' - Black
WW-CE-GY-8
Carpet to Edge Base and Cover 8' - Gray

CE Wire Way Base ONLY

WW-CE-BS-8
Base Only, Carpet To Edge, Black, 8'

CE Wire Way Lens ONLY

WW-TC-CL-8
Lens Cover Only, Clear, 8'
WW-TC-BK-8
Lens Cover Only, Black, 8'
WW-TC-BZ-8
Lens Cover Only, Bronze, 8'
WW-TC-GY-8
Lens Cover Only, Gray, 8'

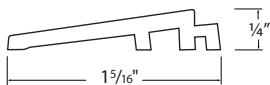

BNS-TT-R-12

Step Reducer, 12' Section

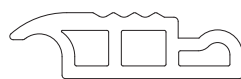

STP-EXTNDR-12

Bullnose Step Landing Tread Extender, 12'



ADH-MB-75AM-10

Extrusion adhesive, 10.1 oz tubes, sold individually. 30 per case.

ADH-MB-75AM-29

Extrusion adhesive, 29 oz tubes, sold individually. 12 per case.

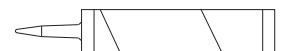

ADH-IA-10.2-CA

End Cap Adhesive, Clear liquid adhesive for end caps. 10.2 oz tubes sold individually. 12 per case.

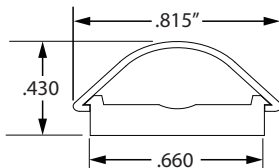

BS-CC-8

Wall wireway, 8' Black Base & Conduit Cover

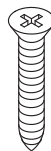

TM-3/16

Concrete Screw 3/16" x 1 3/4"

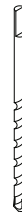

RONDB-5/32

Concrete Drill Bit 5/32"